

GROUP 17 17 HERRAMIENTAS

GROUP 17 17 TOOLS

GROUP 17 17 OUTILS

COMPOSICION.....COMPOSITION.....COMPOSICION

DENOMINACION	DESCRIPTION	DENOMINATION	HOJA PAGE PAGE
HERRAMIENTAS 4C 6C G	TOOLS 4C 6C P	OUTILS 4C 6C E	459
HERRAMIENTAS 88LIG G	TOOLS 88LIG P	OUTILS 88LIG E	460
HERRAMIENTAS 4C D	TOOLS 4C D	OUTILS 4C D	461
HERRAMIENTAS 6C 88LIG D	TOOLS 6C 88LIG D	OUTILS 6C 88LIG D	462
MATERIALES REPARACION	REPAIR MATERIALS	MATERIEL DE REPARATION	463

170106
170103

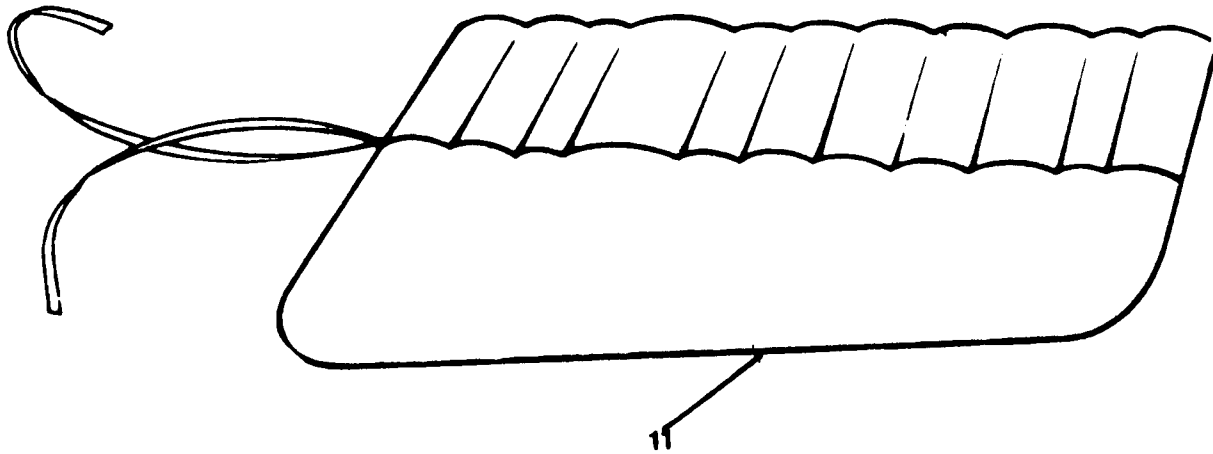
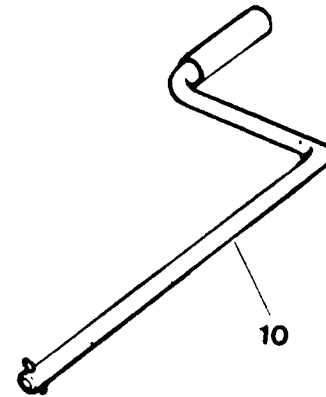
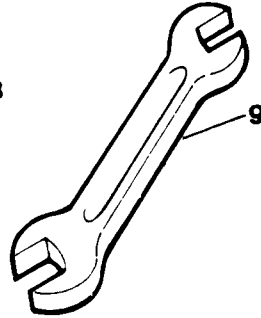
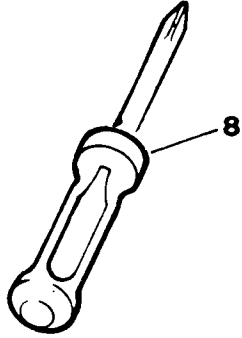
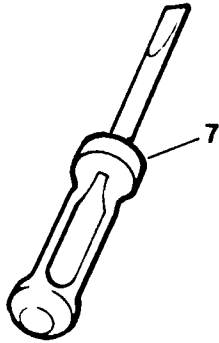
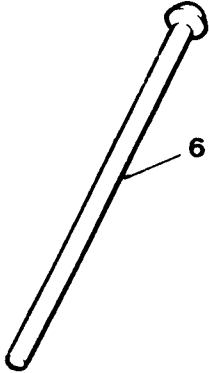
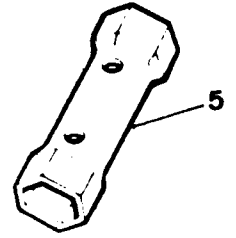
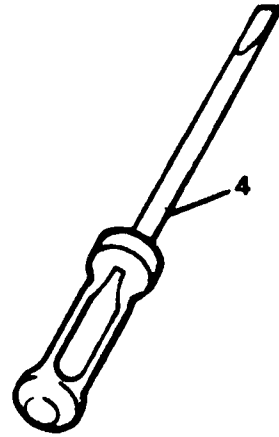
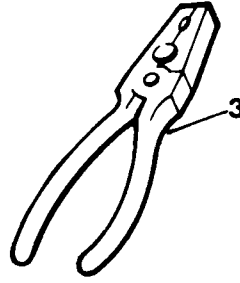
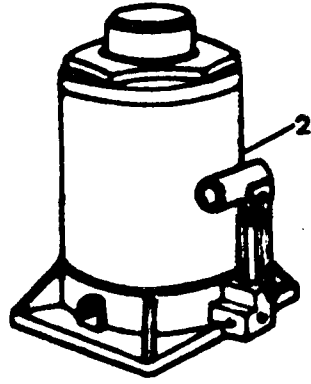
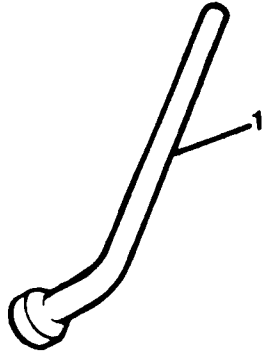

PUBLICACION N 880013
EDICION N 1

GRUPO=17 HERRAMIENTAS
GROUP=17 TOOLS
GROUPE=17 OUTILS

SUBGRUPO=HERRAMIENTAS 4C 6C G
SUBGROUP=TOOLS 4C 6C P
SUBGROUPE=OUTILS 4C 6C E

N.FIG	N.PIEZA	CAN	DENOMINACION	DESCRIPTION	DENOMINATION	C H A S I S
PLATE	PARTNUMBER	QTY				
N.FIG	N.PIECE	OUT				
1	162961	1	LLAVE	BENT SOCKET WRENCH	CLE A DOVILLE COUDEE	
2	278345F1	1	GATO ELEVADOR 2 T	KACK 2 T	CRIC 2 T	
3	2703E1	1	ALICATE	COMBINATIONS PLIERS	PINCES MULTIPLES	
4	234619E1	1	DESTORNILLADOR	SCREW DRIVER	TOURNEVIS	
5	276322	1	LLAVER	CAP KEP	CLE A TUBE	
6	1403	1	PALANCA	LEVER	LEVIER	
7	162952	1	DESTORNILLADOR	SCREW DIVER	TOURNEVIS	
8	162966	1	DESTORNILLADOR	SCREW DIVER	TOURNEVIS	
9	162979	1	LLAVE 11 14	SPANNER 11 14	CLE 11 14	
	162981	1	LLAVE 16 19	SPANNER 16 19	CLE 16 19	
10	218508	1	MANIVELA	STARTING HANDLE	MANIVELLE	
11	219704E1	1	BOLDA DE HERRAMIENTE	TOOL BAG	TROUSSE A OUTILS	

170106
170103

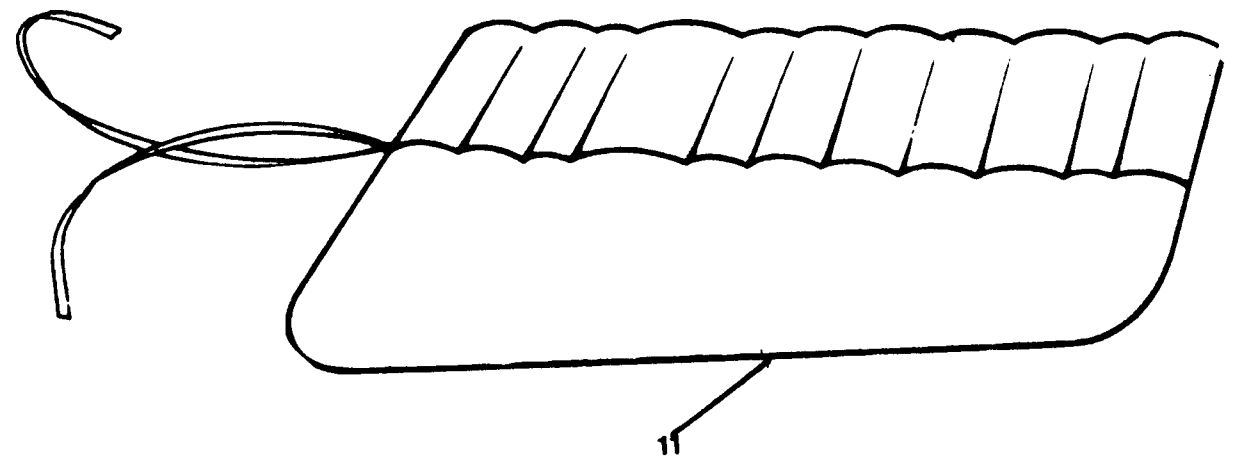
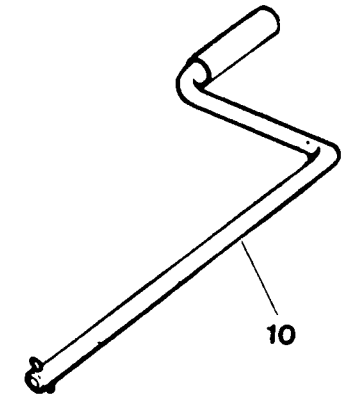
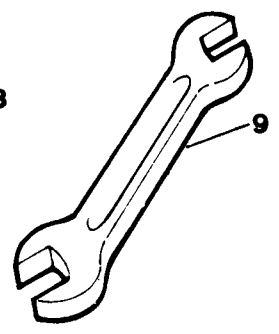
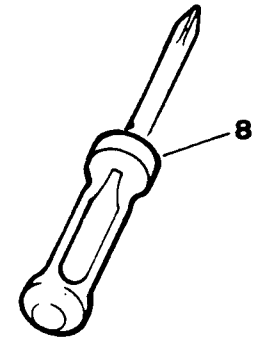
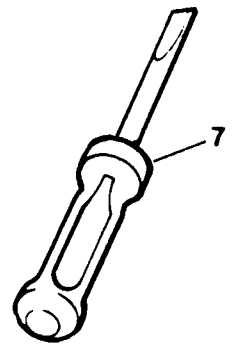
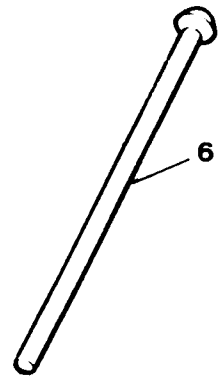
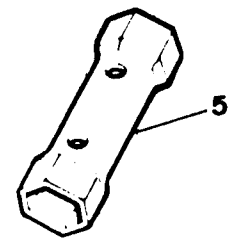
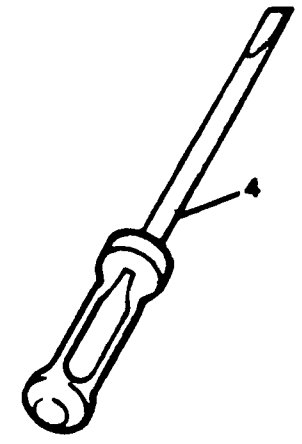
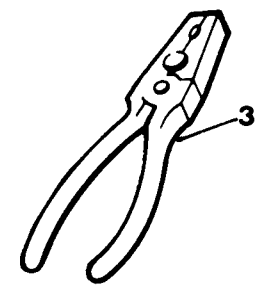
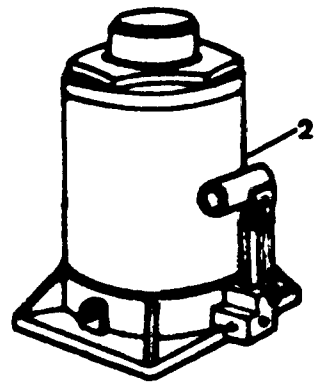
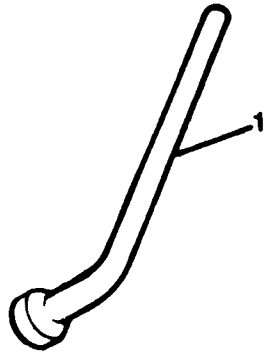

PUBLICACION N 580013
EDICION N 1

GRUPO=17 HERRAMIENTAS
GROUP=17 TOOLS
GROUPE=17 OUTILS

SUBGRUPO=HERRAMIENTAS 88LIG G
SUBGROUP=TOOLS 88LIG P
SUBGROUPE=OUTILS 88LIG E

N.FIG	N.PIEZA	CAN	DE NOMINACION	DESCRIPTION	DE NOMINACION	C H A S I S
PLATE	PART NUMBER	QTY				
N.FIG	N.PIECE	OUT				
1	162901	1	LLAVE	BENT SCKET WRENCH	CLE A DOVILLE COUDEE	
2	278345F1	1	GATO ELEVADOR 2 T	KACK 2T	CRIC 2 T	
3	278301	1	ALICATE	COMBINATIONS PLIERS	PINCES MULTIPLES	
4	234614E1	1	DESTORNILLADOR	SCREW DRIVER	TOURNEVIS	
5	278322	1	LLAVE	CAP KEP	CLE A TUBE	
6	1403	1	PALANCA	LEVER	DLEVIER	
7	162952	1	DESTORNILLADOR	SCREW DRIVER	TOURNEVIS	
8	162904	1	DESTORNILLADOR	SCREW DRIVER	TOURNEVIS	
9	162970	1	LLAVE 11 14	SPANNER 11 14	CLE 11 14	
	16298	1	LLAVE 16 19	SPANNER 16 19	CLE 16 19	
10	218508	1	MANIVELA	STARTING HANDLE	MANIVELLE	
11	219704E1	1	BOLSA DE HERRAMIENTA	TOOL BAG	TROUSSE A OUTILS	

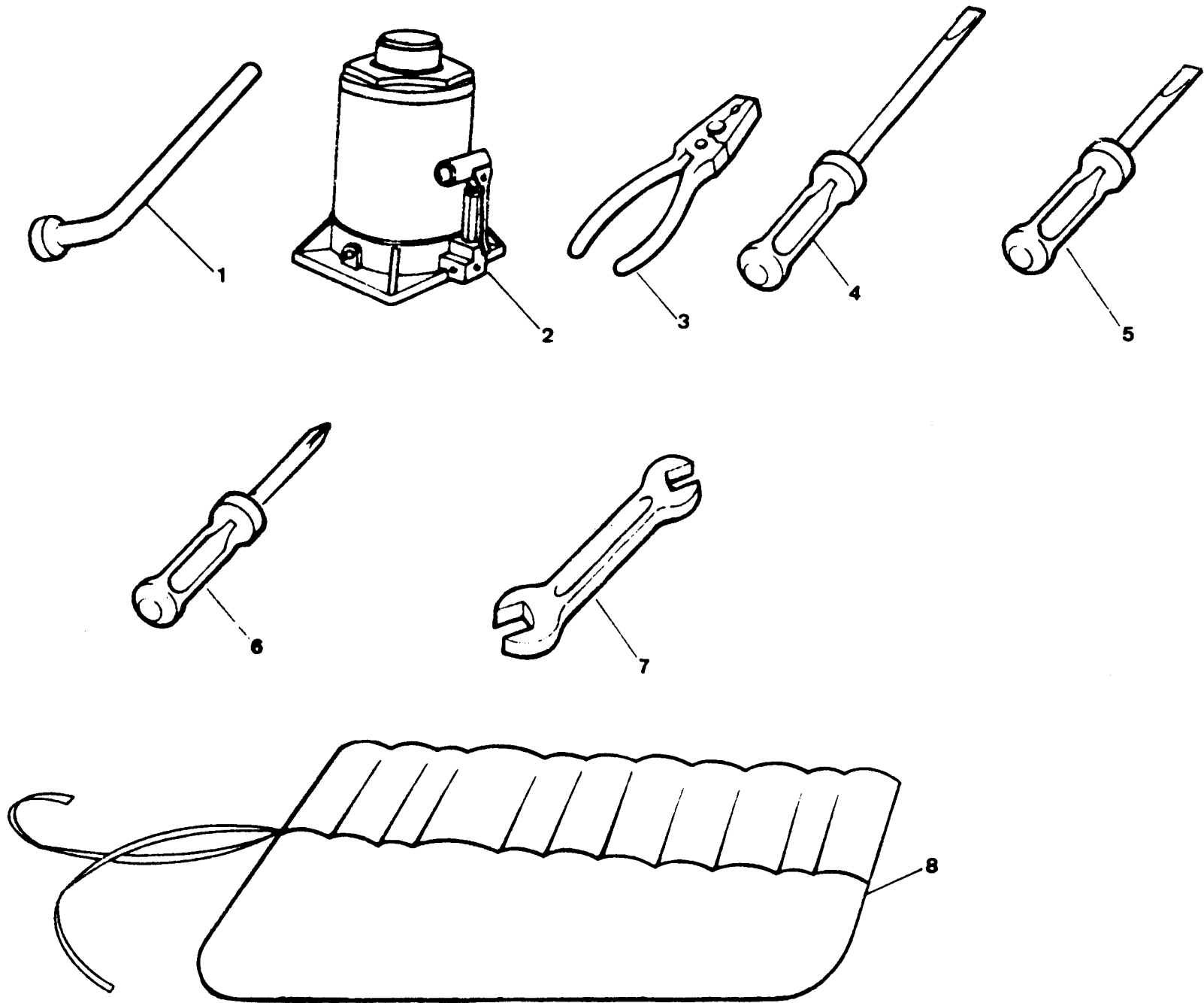

PUBLICACION N 860013
EDICION N 1

GRUPO=17 HERRAMIENTAS
GROUP=17 TOOLS
GROUPE=17 OUTILS

SUBGRUPO=HERRAMIENTAS 4C D
SUBGROUP=TOOLS 4C D
SUBGROUPE=OUTILS 4C D

N.FIG	N.PIEZA	CAN	DENOMINACION	DESCRIPTION	DENOMINATION	C H A S I S
PLATE	PARTNUMBER	QTY				
N.FIG	N.PIECE	OUT				
1	162962	1	LLAVE	BENT SOCKET WRENCH	CLE A DOVILLE COUDEE	
2	278245F1	1	GATO ELEVADOR 2 T	KACK 2 T	CPIC 2 T	
3	2733E1	1	ALICATE	COMBINATIONS PLIERS	PINCES MULTIPLES	
4	234619E1	1	DESTORNILLADOR	SCREW DRIVER	TOURNEVIS	
5	162950	1	DESTORNILLADOR	SCREW DRIVER	TOURNEVIS	
6	162966	1	DESTORNILLADOR	SCREW DRIVER	TOURNEVIS	
7	162979	1	LLAVE 8 9	SPANNER 8 9	CLE 8 9	
	162975	1	LLAVE 11 14	SPANNER 11 14	CLE 11 14	
	162987	1	LLAVE 16 19	SPANNER 16 19	CLE 16 19	
8	219704E1	1	BOLSA DE HERRAMIENTA	TOOL BAG	TROUSSE A OUTILS	

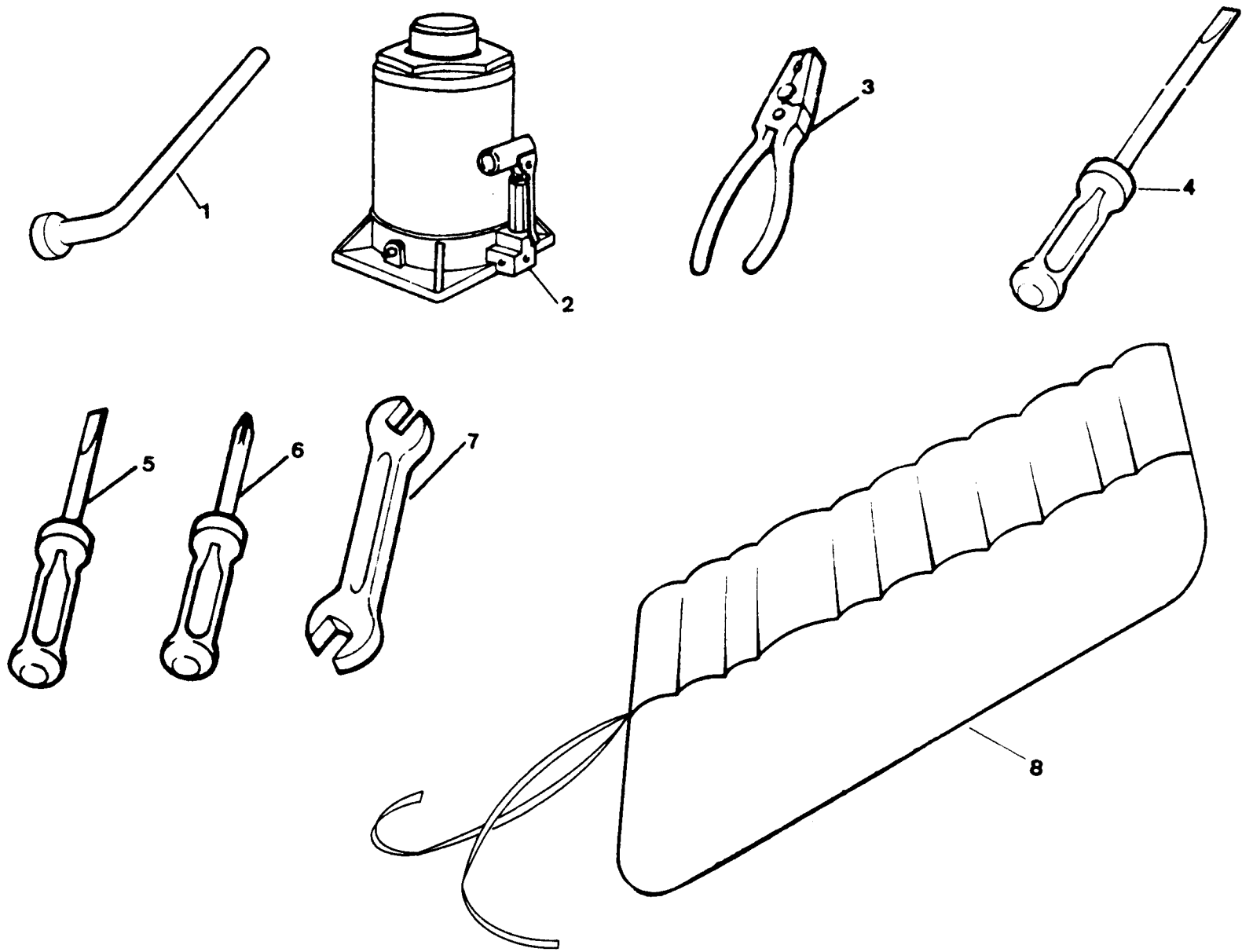

PUBLICACION N 880013
 EDICION N 1

GRUPO=17 HERRAMIENTAS
 GROUP=17 TOOLS
 GROUPE=17 OUTILS

SUBGRUPO=HERPAMEN 6C 88LIG D
 SUBGROUP=TOOLS 6C 88LIG D
 SUBGROUPE=OUTILS 6C 88LIG D

N.FIG	N.PIEZA	CAN	DE NOMINACION	DESCRIPTION	DE NOMINATION	C H A S I S
PLATE	PARTNUMBER	QTY				
N.FIG	N.PIECE	OUT				
1	162961	1	LLAVE	BENT SOCKET WRENCH	CLE A DOVILLE COUDEE	
2	278349F1	1	GATO ELEVADOR 2 T	WACK 2 T	CRIC 2 T	
3	270361	1	ALICATE	COMBINATIONS PLIERS	PINCES MULTIPLES	
4	204619E1	1	DESTORNILLADOR	SCREW DRIVER	TOURNEVIS	
5	162952	1	DESTORNILLADOR	SCREW DRIVER	TOURNEVIS	
6	162966	1	DESTORNILLADOR	SCREW DRIVER	TOURNEVIS	
7	162979	1	LLAVE 8 9	SPANNER 8 9	CLE 8 9	
	162979	1	LLAVE 11 14	SPANNER 11 14	CLE 11 14	
	162981	1	LLAVE 16 19	SPANNER 16 19	CLE 16 19	
8	219704E1	1	BOLSA DE HERRAMIENTA	TOOL BAG	TROUSSE A OUTILS	

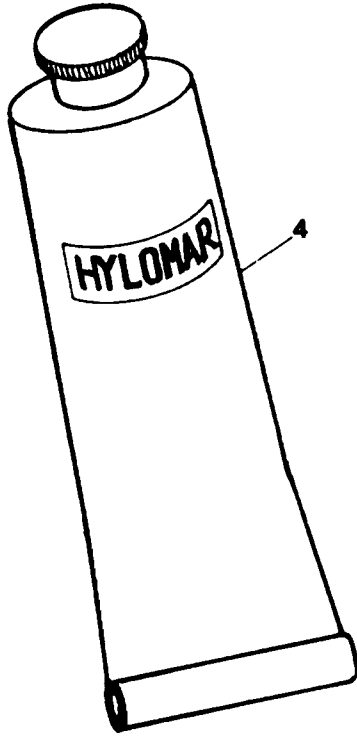
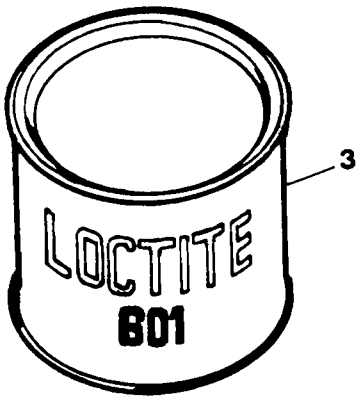

PUBLICACION N 880013
EDICION N 1

GRUPC=17 HERRAMIENTAS
GROUP=17 TOOLS
GROUPE=17 OUTILS

SUBGRUPO=MATERIALES REPARACIO
SUBGROUP=REPAIR MATERIALS
SUBGROUPE=MATERIEL DE REPARATI

N.FIG	N.PIEZA	CAN	DENOMINACION	DESCRIPTION	DENOMINACION	C H A S I S
PLATE	PARTNUMBER	QTY				
N.FIG	N.PIECE	QTY				
1	194041	S-N	LIQUIDO FRENOS 1/2 L	BRAKE FLUID 1/2 L	LIQUIDE DE FRE 1/2L	
	194042	S-N	LIQ 1/2 24 UNIDADES	BRAK 1/2 BOX OF 24	LIQUIDE BOITE DE 24	
	606021	S-N	LIQUIDO DE FRENOS 1L	BRAKE FLUID 1 L	LIQUIDE DE FREINS 1L	
2	605238	S-N	HILC ESPESORES 24 UN	PLASTIGAUGE STRIP	FILAMENT DE EPAISSEU	
3	606146	S-N	LUCTITE	LOCTITE	LOCTITE	
4	534244	S-N	PASTA HYLOMAR	HYLOMAR SEALING COMP	PATE HYLOMAR	